

CERAMIC & TRIMLESS DOWNLIGHTS

## Ceram, Artus & Jazz Series

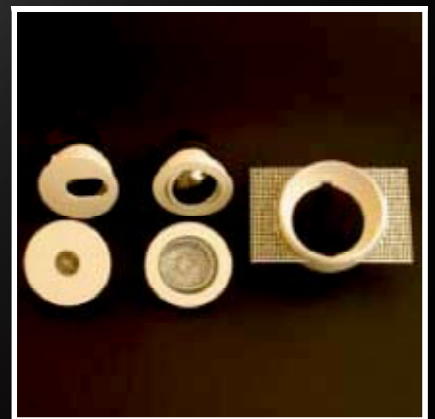

**inox** lighting  
innovators

t +44(0)845 643 9533 f +44(0)845 280 1651 e sales@inox.co.uk w inox.co.uk

# Ceram 3S



The light housing CERAM 3S is suitable for installation in plasterboard ceilings of 12mm thickness. It is made of cast ceramic material with an inner downlight component of cast aluminium. Versions are offered for 12V halogen, 230V halogen or LED and compact metal halide lamps.

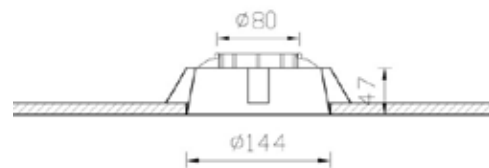

## Lamps:



ES 50, max 50W, GU10, 230V  
HALOGEN LAMP



QR-CBC 51, max 50W, GU5.3, 12V  
HALOGEN LAMP WITH  
DICHROIC REFLECTOR

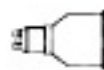

CFL, max 9W, GU10, 230V  
COMPACT FLUORESCENT LAMP  
/ 9W TOSHIBA LED



ES 50, max 35W, GX10  
METAL HALIDE LAMP, BRITESPOT

**Colours:** Uncoloured



EN ISO 9001 : 2008



Design Production & Commerce of Lighting Products  
Application Study of lighting System



ISO 14001 : 2004 + Cor1 : 2009



**inox** lighting  
innovators

t +44(0)845 643 9533 f +44(0)845 280 1651

e sales@inox.co.uk w inox.co.uk

# Ceram 3S 2F



The light housing CERAM 3S2F is suitable for installation in plasterboard ceilings of 12mm thickness. It is made of cast ceramic material with an inner downlight component of cast aluminium. Versions are offered for 12V halogen, 230V halogen or LED and compact metal halide lamps.

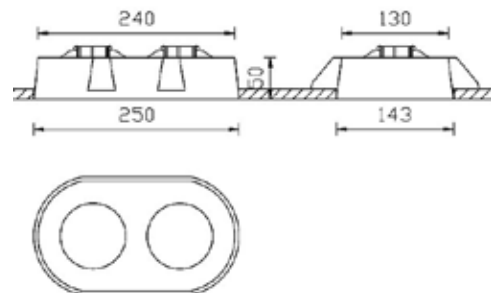

## Lamps:

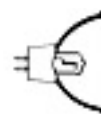

QR-CBC 51, max 50W,  
GU5.3, 12V  
HALOGEN LAMP WITH  
DICHROIC REFLECTOR



ES 50, max 50W, GU10, 230V  
HALOGEN LAMP

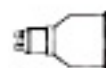

CFL, max 9W, GU10, 230V  
COMPACT FLUORESCENT LAMP  
/ 9W TOSHIBA LED



ES 50, max 35W, GX10  
METAL HALIDE LAMP, BRITESPOT

**Colours:** Uncoloured



EN ISO 9001 : 2008



Design Production & Commerce of Lighting Products  
Application Study of lighting System



ISO 14001 : 2004 + Cor1 : 2009



**inox** lighting  
innovators

t +44(0)845 643 9533 f +44(0)845 280 1651

e sales@inox.co.uk w inox.co.uk

# Ceram 4S



The light housing CERAM 4S is suitable for installation in plasterboard ceilings of 12mm thickness. It is made of cast ceramic material with an inner downlight component of cast aluminium. Versions are offered for 12V halogen, 230V halogen or LED and compact metal halide lamps.

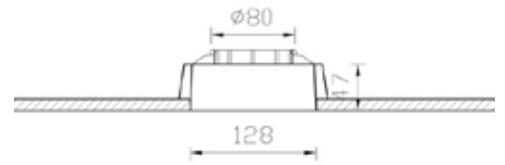

## Lamps:

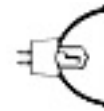

QR-CBC 51, max 50W, GU5.3, 12V  
HALOGEN LAMP WITH  
DICHROIC REFLECTOR



ES 50, max 50W, GU10, 230V  
HALOGEN LAMP

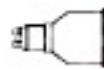

CFL, max 9W, GU10, 230V  
COMPACT FLUORESCENT LAMP  
/ 9W TOSHIBA LED



ES 50, max 35W, GX10  
METAL HALIDE LAMP, BRITESPOT

**Colours:** Uncoloured



EN ISO 9001 : 2008  
Design Production & Commerce of Lighting Products  
Application Study of lighting System



**inox** lighting  
innovators

t +44(0)845 643 9533 f +44(0)845 280 1651

e sales@inox.co.uk w inox.co.uk

# Ceram 4S 2F



The light housing CERAM 4S2F is suitable for installation in plasterboard ceilings of 12mm thickness. It is made of cast ceramic material with an inner downlight component of cast aluminium. Versions are offered for 12V halogen, 230V halogen or LED and compact metal halide lamps.

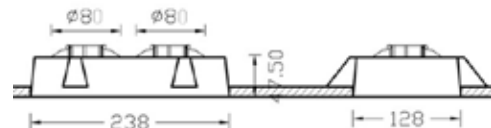

## Lamps:



QR-CBC 51, max 50W, GU5.3, 12V  
HALOGEN LAMP WITH  
DICHROIC REFLECTOR



ES 50, max 50W, GU10, 230V  
HALOGEN LAMP

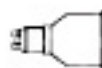

CFL, max 9W, GU10, 230V  
COMPACT FLUORESCENT LAMP  
/ 9W TOSHIBA LED



ES 50, max 35W, GX10  
METAL HALIDE LAMP, BRITESPOT

**Colours:** Uncoloured



EN ISO 9001 : 2008



Design Production & Commerce of Lighting Products  
Application Study of lighting System



ISO 14001 : 2004 + Cor1 : 2009



**inox** lighting  
innovators

t +44(0)845 643 9533 f +44(0)845 280 1651

e sales@inox.co.uk w inox.co.uk

# Artus 1



The luminaire ARTUS 1 is suitable for plasterboard ceilings. It is made of cast aluminium and fits flush for a trimless appearance. Four inner housings are available, offering choice of fixed, adjustable, pinhole and adjustable pinhole styles. Versions are available of 230V and 12V halogen or LED lamps.

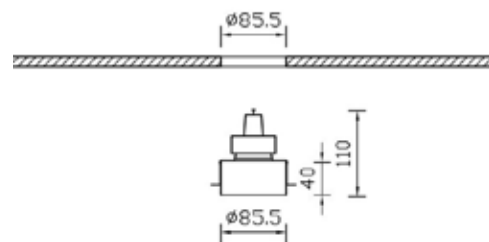

## Lamps:



QR-CBC 51, max 50W, GU5.3, 12V  
HALOGEN LAMP WITH  
DICHROIC REFLECTOR



ES 50, max 50W, GU10, 230V  
HALOGEN LAMP



ES50 LED / 9W TOSHIBA LED

**Colours:** White, black & grey



EN ISO 9001 : 2008



Design Production & Commerce of Lighting Products  
Application Study of lighting System



ISO 14001 : 2004 + Cor1 : 2009



**inox** lighting  
innovators

t +44(0)845 643 9533 f +44(0)845 280 1651

e sales@inox.co.uk w inox.co.uk

# Artus Square 1

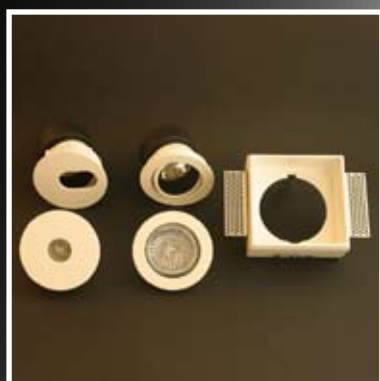

The luminaire ARTUS SQUARE 1 is suitable for plasterboard ceilings. It is made of cast aluminium and fits flush for a trimless appearance. Four inner housings are available, offering choice of fixed, adjustable, pinhole and adjustable pinhole styles. Versions are available of 230V and 12V halogen or LED lamps.

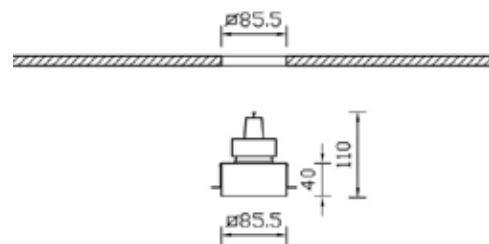

## Lamps:



QR-CBC 51, max 50W, GU5.3, 12V HALOGEN LAMP WITH DICHROIC REFLECTOR



ES 50, max 50W, GU10, 230V HALOGEN LAMP



ES50 LED / 9W TOSHIBA LED

**Colours:** White, black & grey



Design Production & Commerce of Lighting Products  
Application Study of lighting System



**inox** lighting  
innovators

t +44(0)845 643 9533 f +44(0)845 280 1651

e sales@inox.co.uk w inox.co.uk

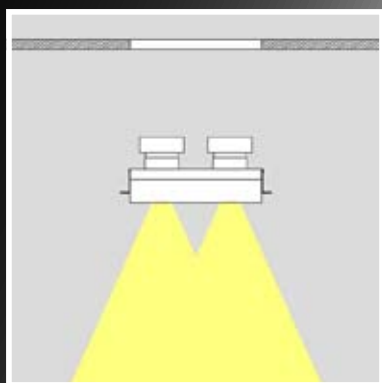

# Orbis 2F

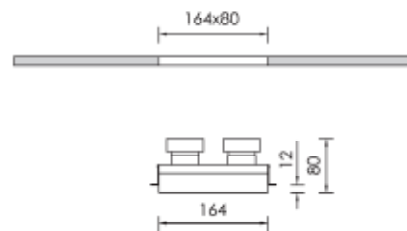

The luminaire ORBIS 2F is suitable for plasterboard ceilings and fits flush for a trimless appearance. It is made of cast aluminium and has a holder system of two steel strings. Two inner bodies may be selected from fixed, adjustable, pinhole and adjustable pinhole options. Versions are available for 230V and 12V halogen and LED lamps.



## Lamps:

-  CFL, max 50W, GU10, 230V  
COMPACT FLUORESCENT LAMP
-  ES 50, max 50W, GU10, 230V  
HALOGEN LAMP
-  QR-CBC 51, max 50W, GU5.3, 12V  
HALOGEN LAMP WITH  
DICHROIC REFLECTOR
-  ES50 LED

**Colours:** White, black & grey



**inox** lighting innovators

t +44(0)845 643 9533 f +44(0)845 280 1651  
e sales@inox.co.uk w inox.co.uk





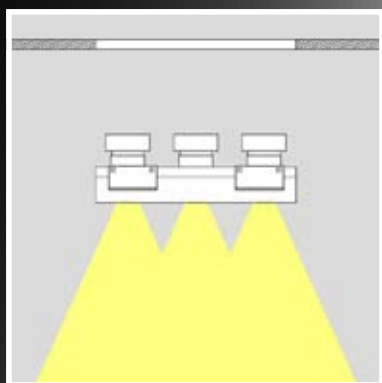

# Orbis 3F

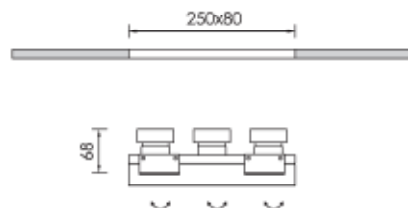

The luminaire ORBIS 3F is suitable for plasterboard ceilings and fits flush for a trimless appearance. It is made of cast aluminium and has a holder system of two steel strings. Two inner bodies may be selected from fixed, adjustable, pinhole and adjustable pinhole options. Versions are available for 230V and 12V halogen and LED lamps.

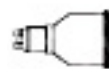

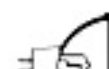
## Lamps:

-  CFL, max 50W, GU10, 230V  
COMPACT FLUORESCENT LAMP
-  ES 50, max 50W, GU10, 230V  
HALOGEN LAMP
-  QR-CBC 51, max 50W, GU5.3, 12V  
HALOGEN LAMP WITH  
DICHROIC REFLECTOR
-  ES50 LED

**Colours:** White, black & grey



**inox** lighting  
innovators

t +44(0)845 643 9533 f +44(0)845 280 1651  
e sales@inox.co.uk w inox.co.uk

# Ceram 3



The light housing CERAM 3 is suitable for installation in plasterboard ceilings of 12mm thickness. It is made of cast ceramic material with an inner downlight component of cast aluminium. Versions are offered for 12V halogen, 230V halogen or LED and compact metal halide lamps.

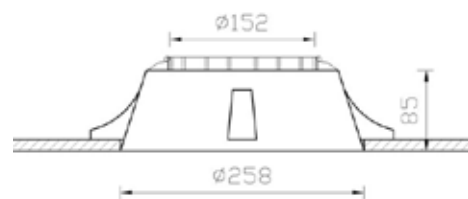

## Lamps:



HIT, max 150W, G12  
METAL HALIDE LAMP



QR 111, max 100W, G53, 12V  
HALOGEN LAMP



PAR 36, max 50W, M4, 12V  
HALOGEN LAMP



CDM R111, max 70W, GX8.5  
METAL HALIDE LAMP



HCI T, max 70W, G8.5  
METAL HALIDE LAMP



QT 18, max 150W, B15d, 230V  
HALOGEN LAMP



ES 111, max 75W, GU10, 230V  
HALOGEN LAMP

**Colours:** Uncoloured



EN ISO 9001 : 2008



Design Production & Commerce of Lighting Products  
Application Study of lighting System



ISO 14001 : 2004 + Cor1 : 2009



**inox** lighting  
innovators

t +44(0)845 643 9533 f +44(0)845 280 1651

e sales@inox.co.uk w inox.co.uk

# Ceram 3L



The light housing CERAM 3 is suitable for installation in plasterboard ceilings of 12mm thickness. It is made of cast ceramic material with an inner downlight component of cast aluminium. Versions are offered for 12V halogen, 230V halogen or LED and compact metal halide lamps.

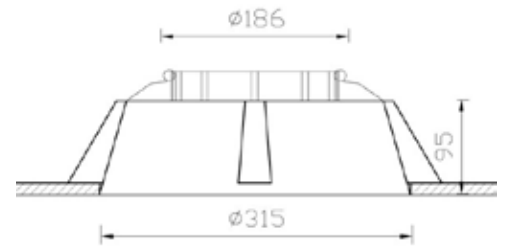

## Lamps:



HIT, max 150W, G12  
METAL HALIDE LAMP



TC-DE, max 2x32W, 4Pins, G24q  
COMPACT FLUORESCENT LAMP



TC-D, max 2x26W, 2Pins, G24d  
COMPACT FLUORESCENT LAMP



QT DE 12, max 300W, R7s,  
230V, 118mm  
HALOGEN LAMP



HIT DE, max 150W, RX7s  
METAL HALIDE LAMP

**Colours:** Uncoloured



**inox** lighting  
innovators

t +44(0)845 643 9533 f +44(0)845 280 1651

e sales@inox.co.uk w inox.co.uk

# Ceram 4M



The light housing CERAM 4M is suitable for installation in plasterboard ceilings of 12mm thickness. It is made of cast ceramic material with an inner downlight component of cast aluminium. Versions are offered for 12V halogen, 230V halogen or LED and compact metal halide lamps.

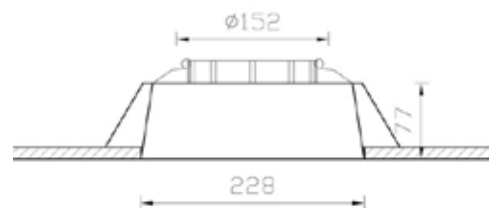

## Lamps:



ES 111, max 75W, GU10, 230V  
HALOGEN LAMP



QT 18, max 150W, B15d, 230V  
HALOGEN LAMP



HCI T, max 70W, G8.5  
METAL HALIDE LAMP



CDM R111, max 70W, GX8.5  
METAL HALIDE LAMP



PAR 36, max 50W, M4, 12V  
HALOGEN LAMP



QR 111, max 100W, G53, 12V  
HALOGEN LAMP



HIT, max 150W, G12  
METAL HALIDE LAMP

**Colours:** Uncoloured



**inox** lighting  
innovators

t +44(0)845 643 9533 f +44(0)845 280 1651

e sales@inox.co.uk w inox.co.uk

# Ceram 4L



The light housing CERAM 4L is suitable for installation in plasterboard ceilings of 12mm thickness. It is made of cast ceramic material with an inner downlight component of cast aluminium. Versions are offered for 12V halogen, 230V halogen or LED and compact metal halide lamps.

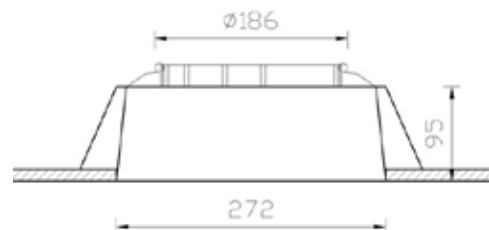

## Lamps:

-  TC-DE, max 2x32W, 4Pins, G24q  
COMPACT FLUORESCENT LAMP
-  TC-D, max 2x26W, 2Pins, G24d  
COMPACT FLUORESCENT LAMP
-  QT DE 12, max 300W, R7s,  
230V, 118mm  
HALOGEN LAMP
-  HIT DE, max 150W, RX7s  
METAL HALIDE LAMP
-  HIT, max 150W, G12  
METAL HALIDE LAMP

**Colours:** Uncoloured



**inox** lighting  
innovators

t +44(0)845 643 9533 f +44(0)845 280 1651

e sales@inox.co.uk w inox.co.uk

# Jazz

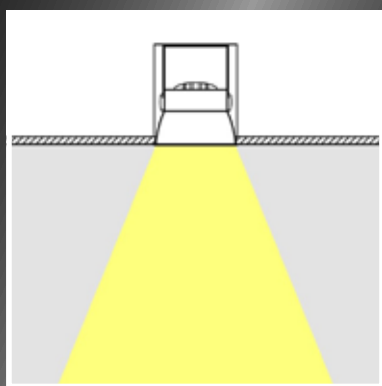

The luminaire JAZZ is suitable for plasterboard ceilings. It is made of cast aluminium. The inner part rotates and tilts. It operates at 230V/50-60Hz. Versions are available for 230V and 12V halogen and LED lamps.

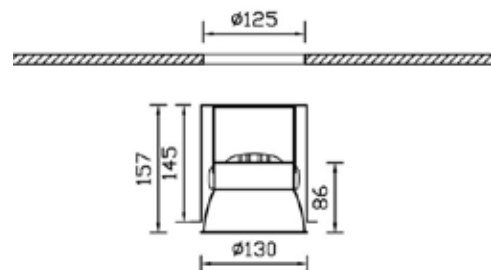

## Lamps:

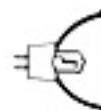

QR-CBC 51, max 50W, GU5.3, 12V  
HALOGEN LAMP WITH  
DICHROIC REFLECTOR



ES 50, max 50W, GU10, 230V  
HALOGEN LAMP



ES 50, max 35W, GX10  
METAL HALIDE LAMP, BRITESPOT

**Colours:** White, black & grey

**inox** lighting  
innovators

t +44(0)845 643 9533 f +44(0)845 280 1651

e sales@inox.co.uk w inox.co.uk



Design Production & Commerce of Lighting Products  
Application Study of lighting System



# Jazz Max

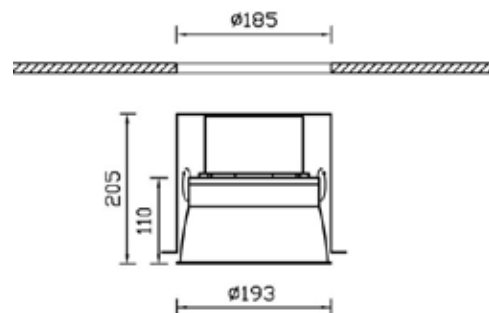

## Lamps:



ES 111, max 75W, GU10, 230V  
HALOGEN LAMP



PAR 36, max 50W, M4, 12V  
HALOGEN LAMP



QR 111, max 100W, G53, 12V  
HALOGEN LAMP



The luminaire JAZZ MAX is suitable for plasterboard ceilings. It is made of cast aluminium. The inner part rotates and tilts. It operates at 230V/50-60Hz. Versions are available for 230V and 12V halogen and LED lamps.

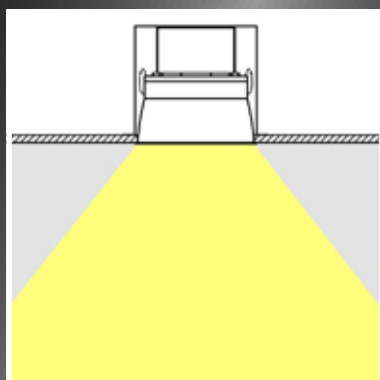

**Colours:** White, black & grey

**inox** lighting  
innovators

t +44(0)845 643 9533 f +44(0)845 280 1651  
e sales@inox.co.uk w inox.co.uk



Design Production & Commerce of Lighting Products  
Application Study of lighting System

